

KB2-325AE1.1
 (標準, VC40, 94)

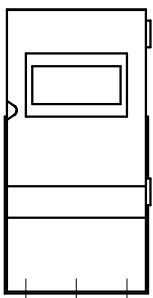

(制御盤正面図)

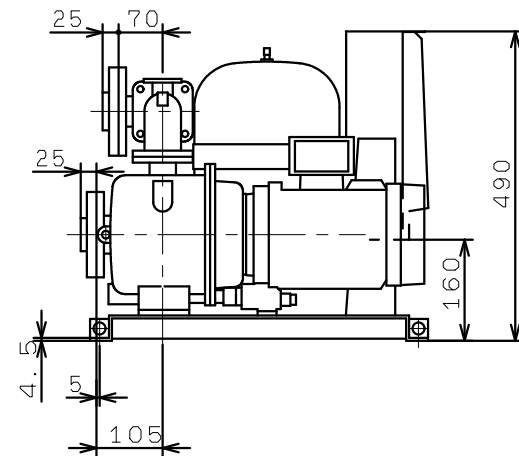
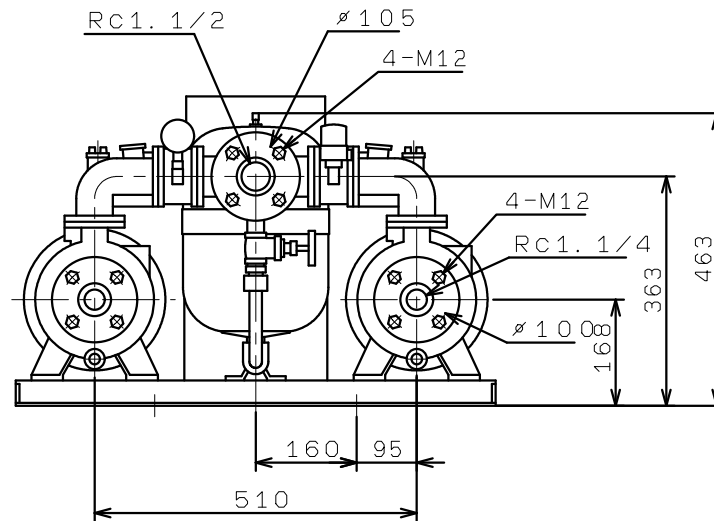
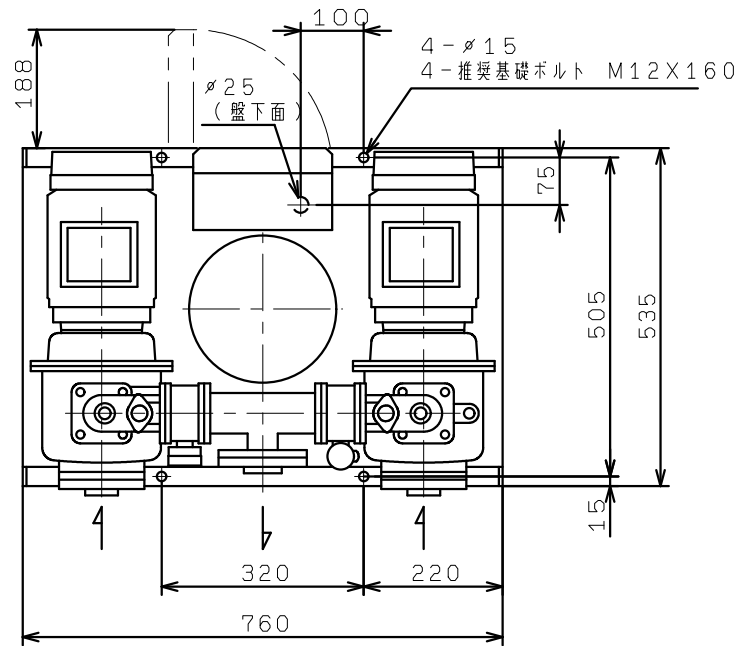