

KB2-326PE1.1
 (VC41, 42, 43, 44, 47)

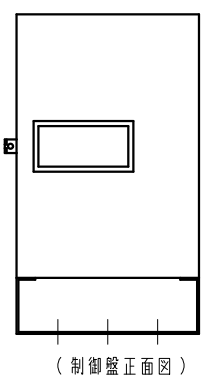

(制御盤正面図)

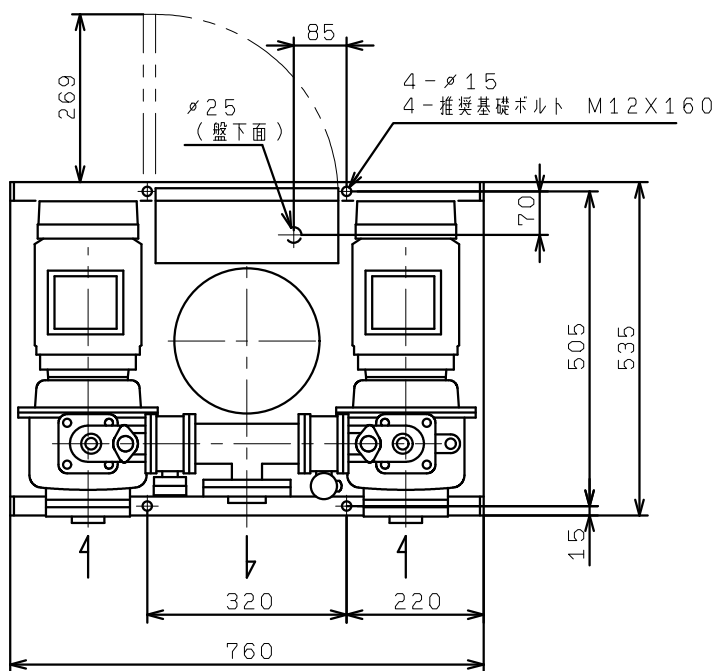