

KB2-326PE1.1  
(VC81)

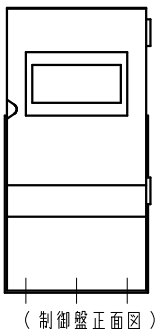

(制御盤正面図)

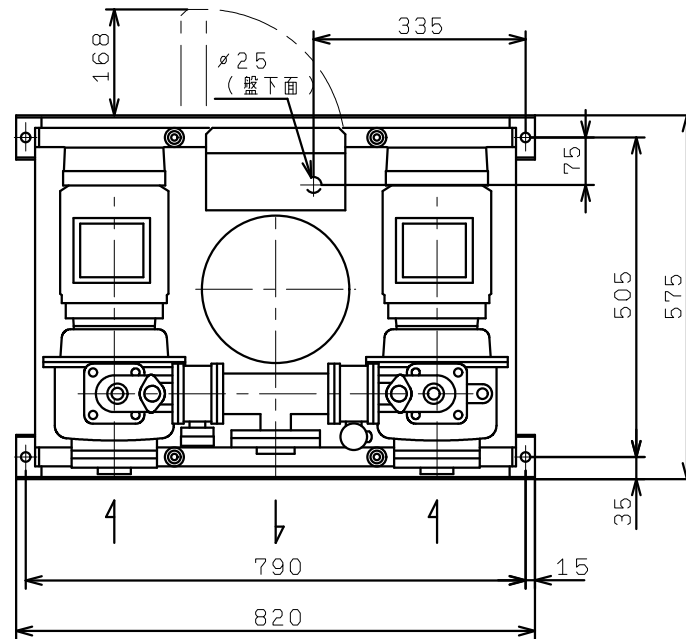