

KB2-325SE0.75
 KB2-326SE0.75
 (VC42, 43, 44)

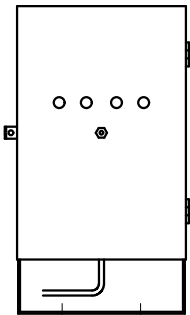

(制御盤正面図)

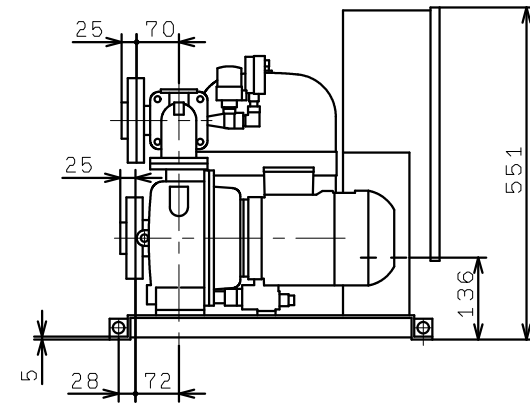
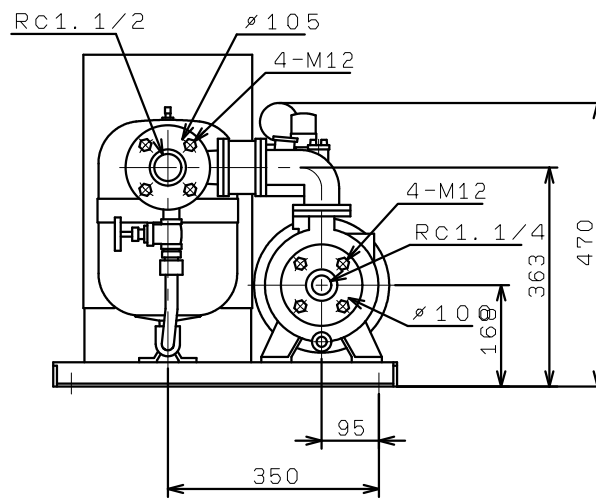
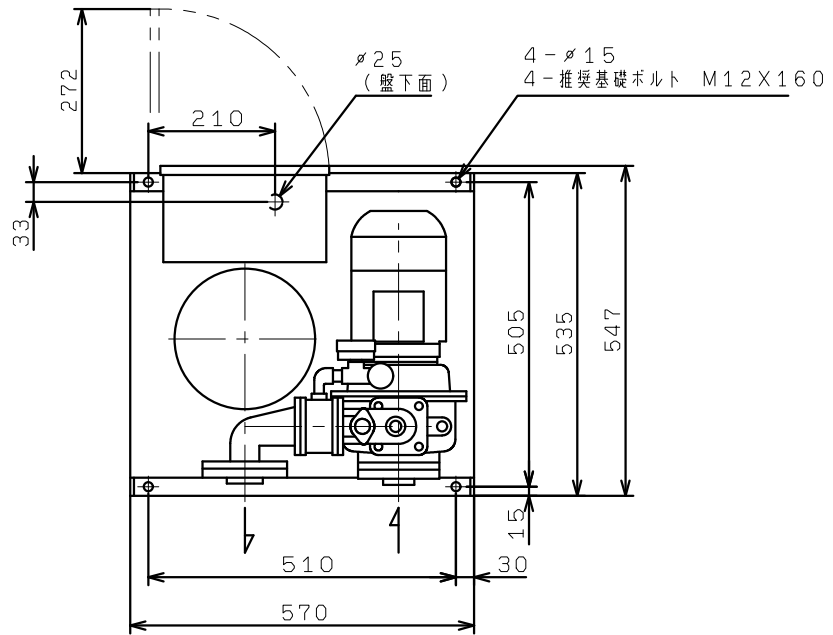