

KB2-405AE3.7
(VC81)

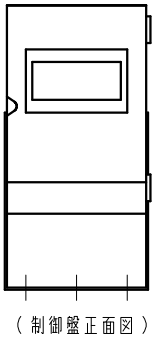

(制御盤正面図)

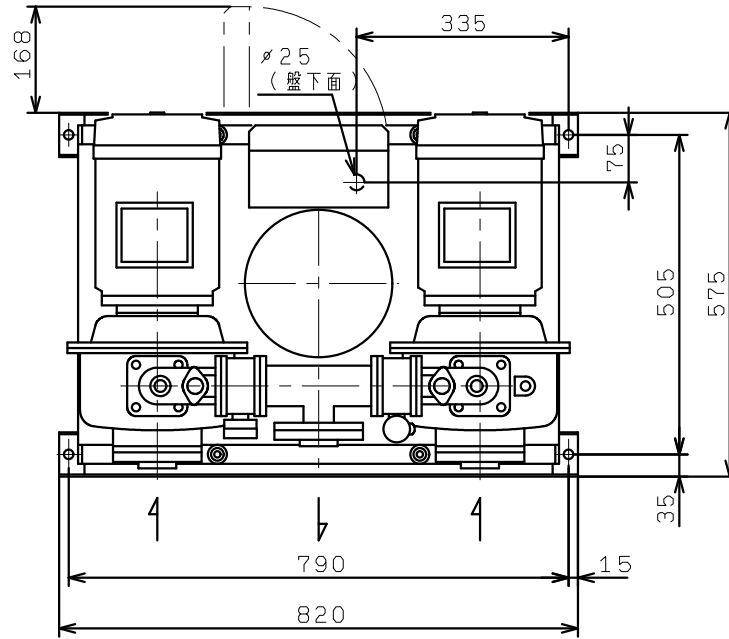