

KB2-406AE3.7  
 (標準, VC40, 94)

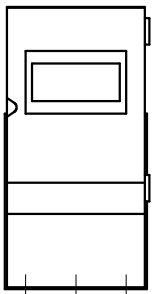

(制御盤正面図)

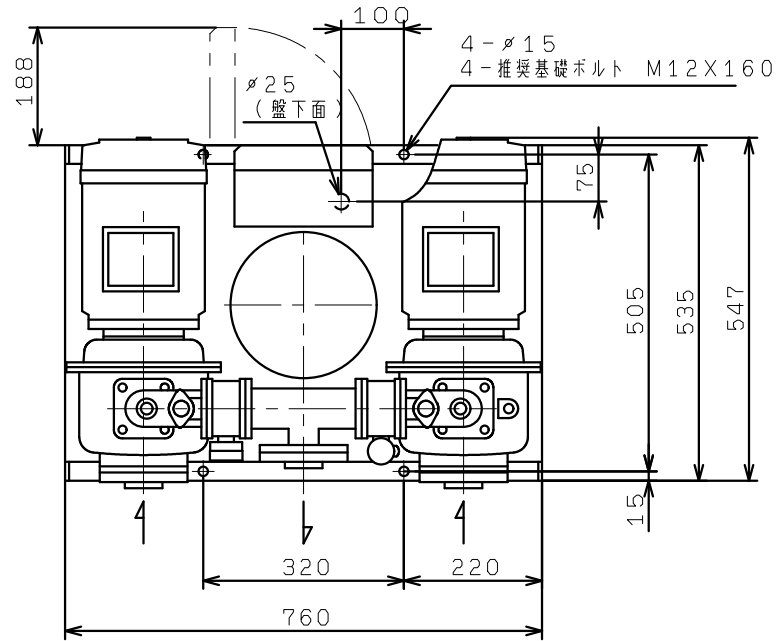