

KB2-406SE3.7
(VC41)

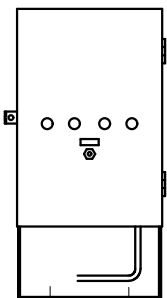

(制御盤正面図)

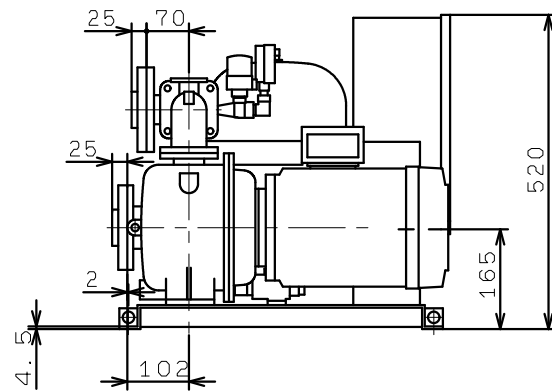
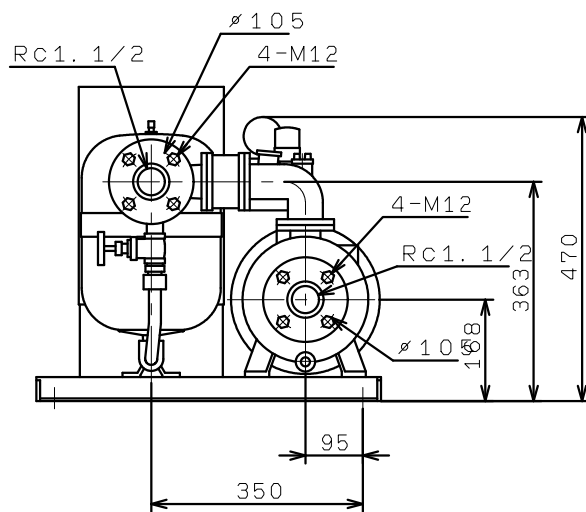
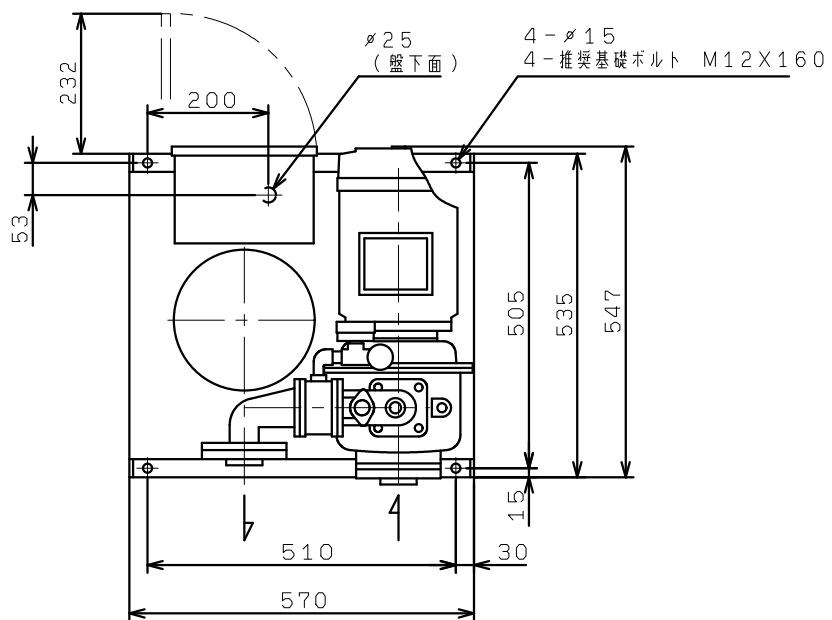