

KB2-405AE1.1
 KB2-406AE1.1
 (標準, VC40, 94)

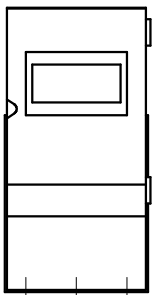

(制御盤正面図)

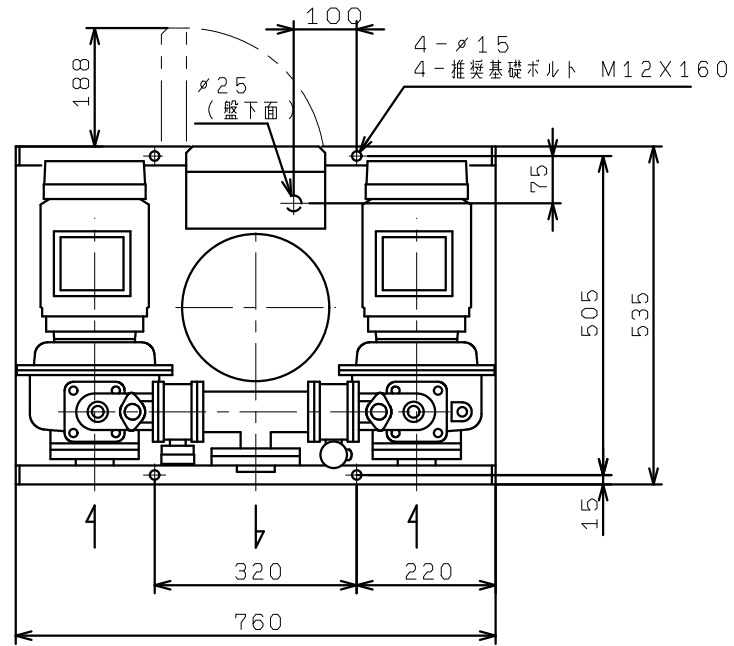