

KB2-405PE0.75
 KB2-406PE0.75
 (標準, VC40, 94)

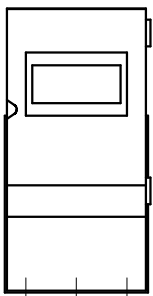

(制御盤正面図)

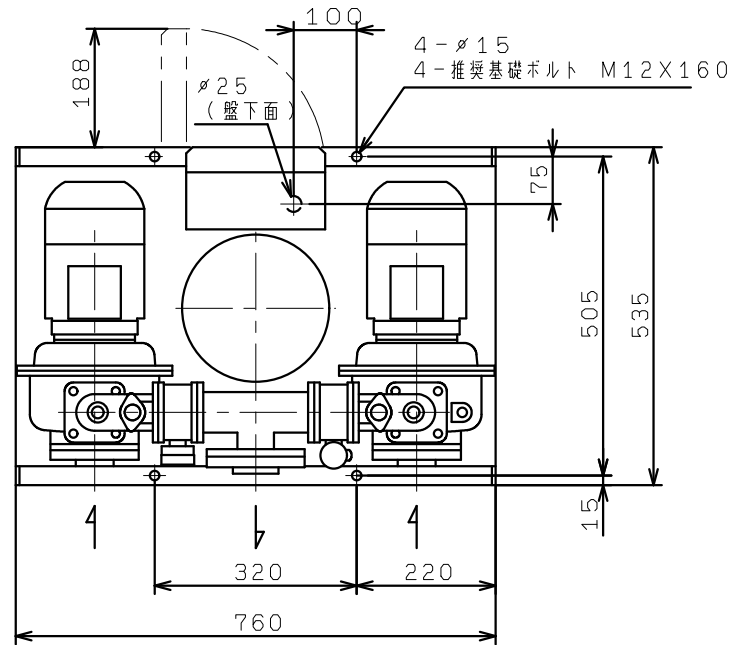