

KB2-405PE0.75
 KB2-406PE0.75
 (VC41, 42, 43, 44, 47)

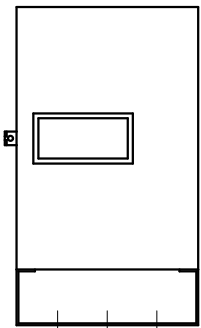

(制御盤正面図)

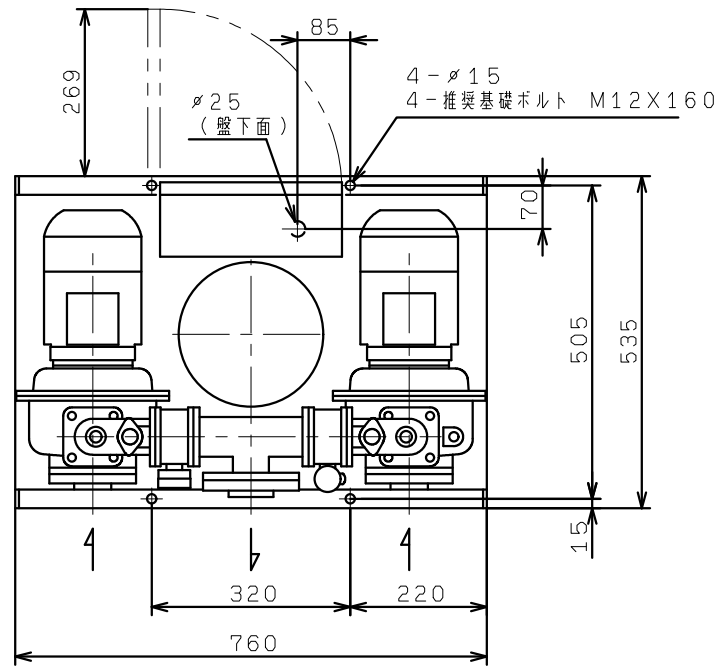