

KB2-405PE1.1  
 KB2-406PE1.1  
 (標準, VC40, 94)

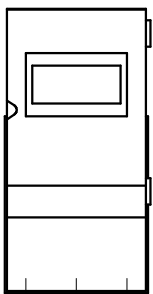

(制御盤正面図)

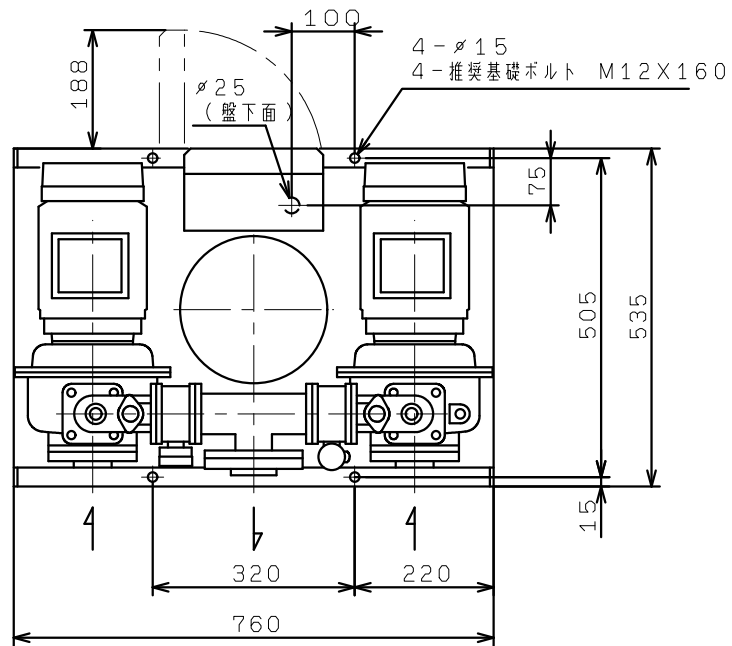