

KB2-405PE1.1
 KB2-406PE1.1
 (VC81)

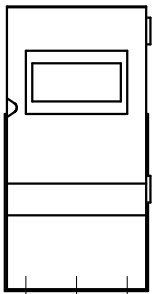

(制御盤正面図)

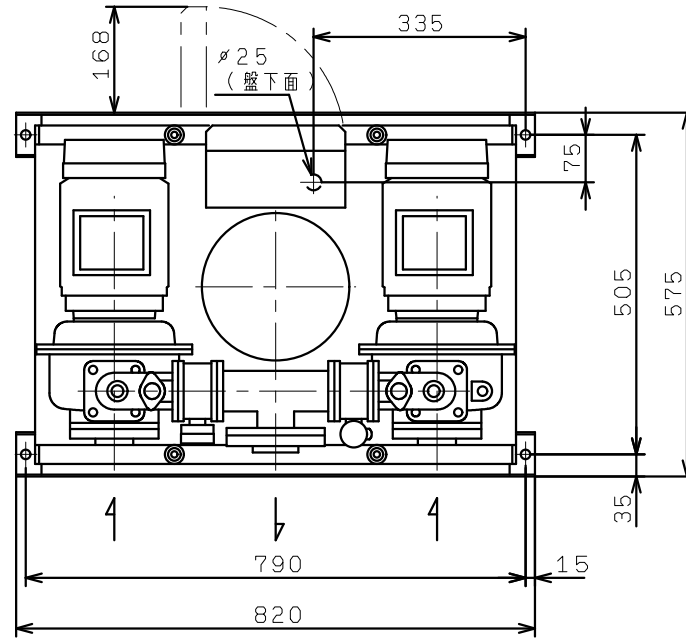