

KB2-405PE2.2
 KB2-406PE2.2
 (VC81)

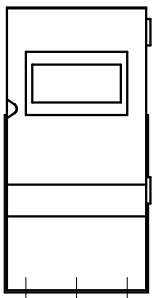

(制御盤正面図)

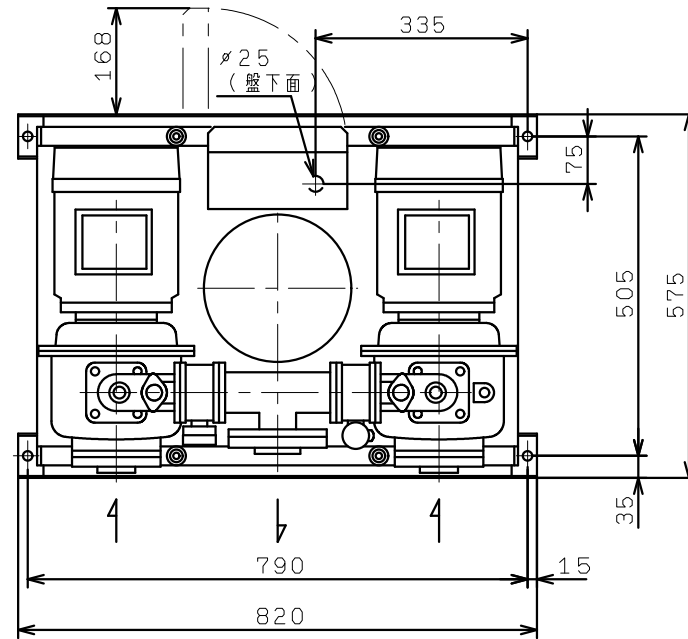