

KB2-405SE1.5  
 KB2-406SE1.5  
 (VC41)

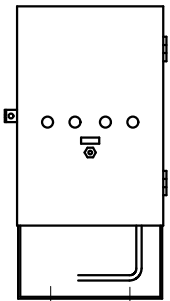

(制御盤正面図)

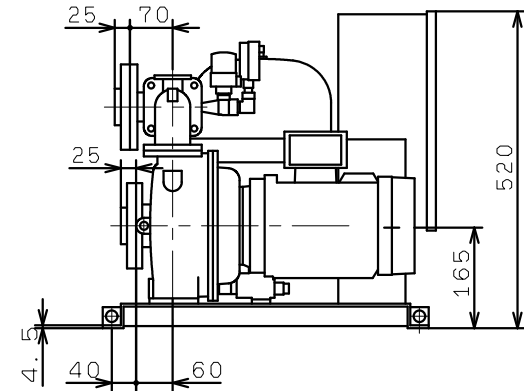
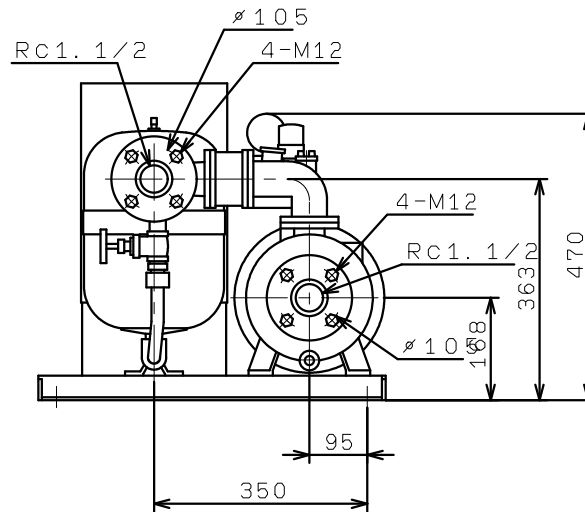
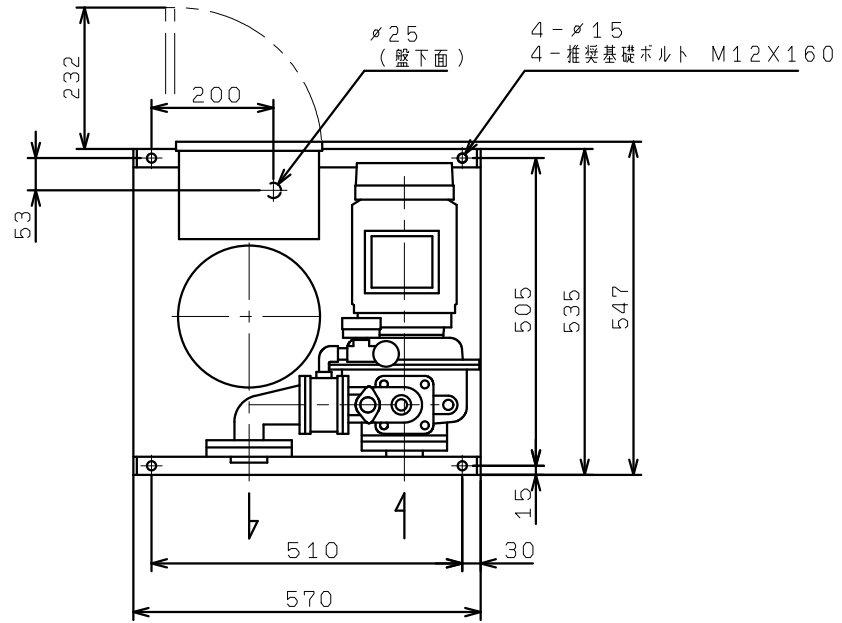