

KB2-506PE2.2  
 (標準, VC40, 94)

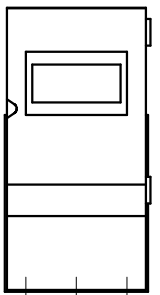

(制御盤正面図)

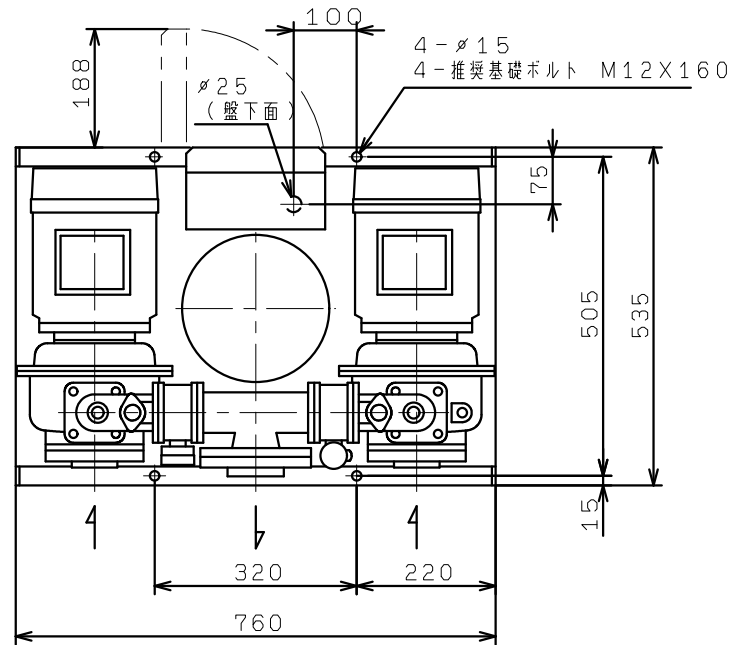