

KB2-505AE1.5  
 KB2-506AE1.5  
 (VC41, 42, 43, 44, 47)

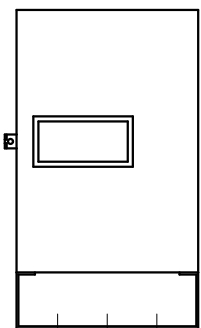

(制御盤正面図)

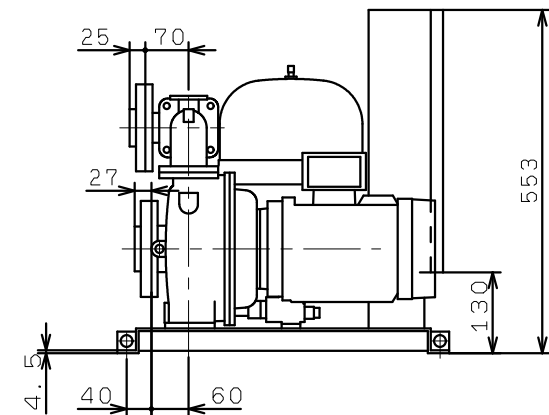
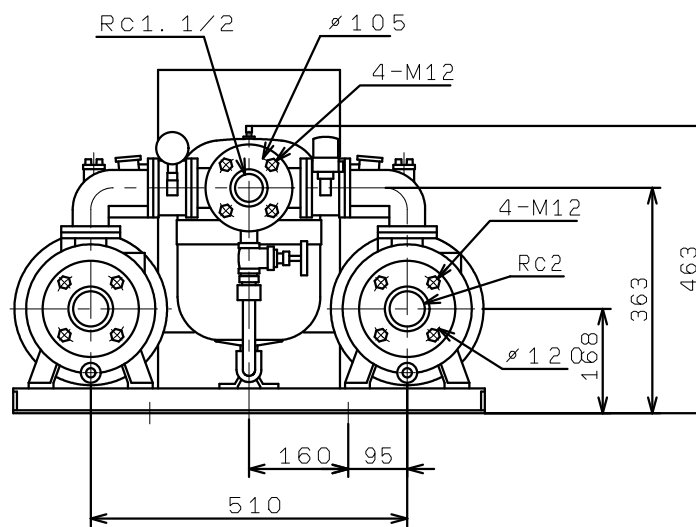
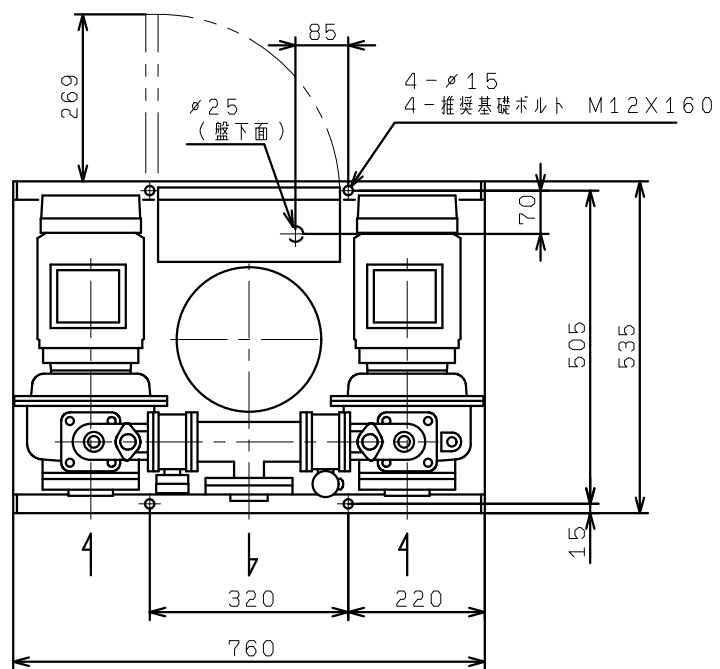