

KB2-505AE3.7  
 KB2-506AE3.7  
 (VC41, 42, 43, 44, 47)

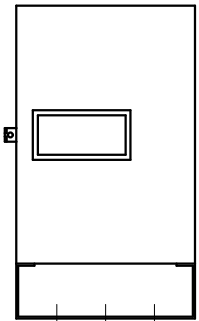

(制御盤正面図)

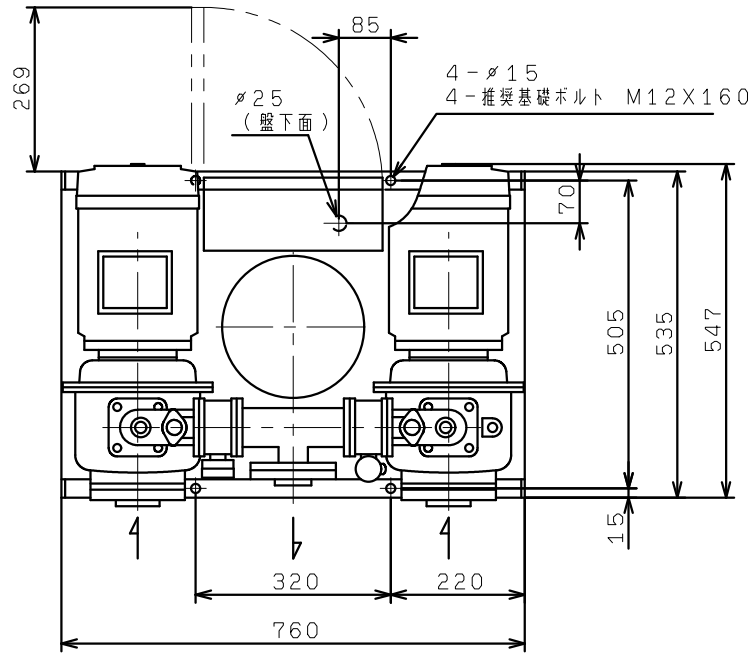