

KB2-505PE1.5
 KB2-506PE1.5
 (標準, VC40, 94)

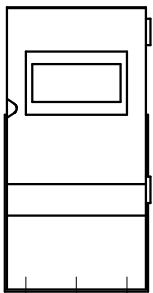

(制御盤正面図)

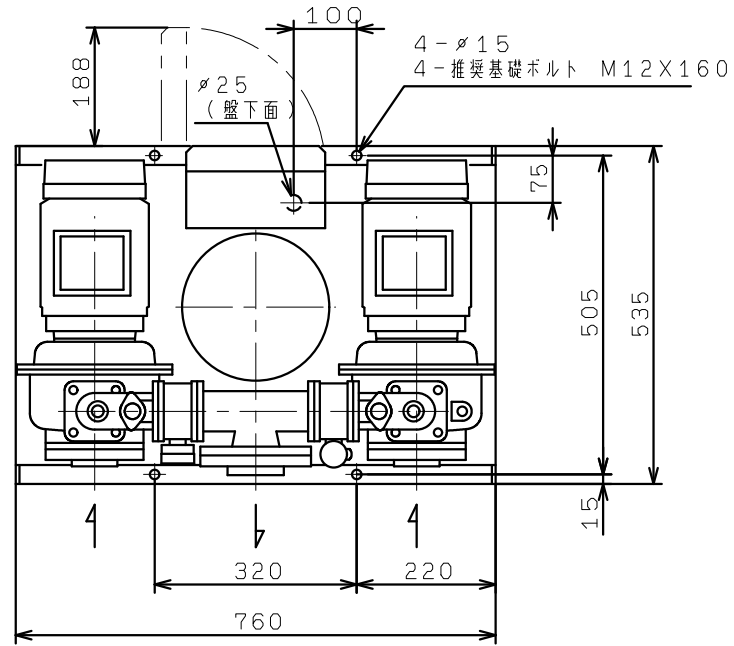