

KB2-505P3.7
 KB2-506P3.7
 (標準, VC40, 94)

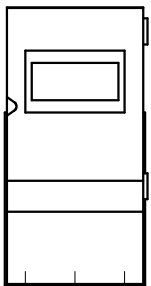

(制御盤正面図)

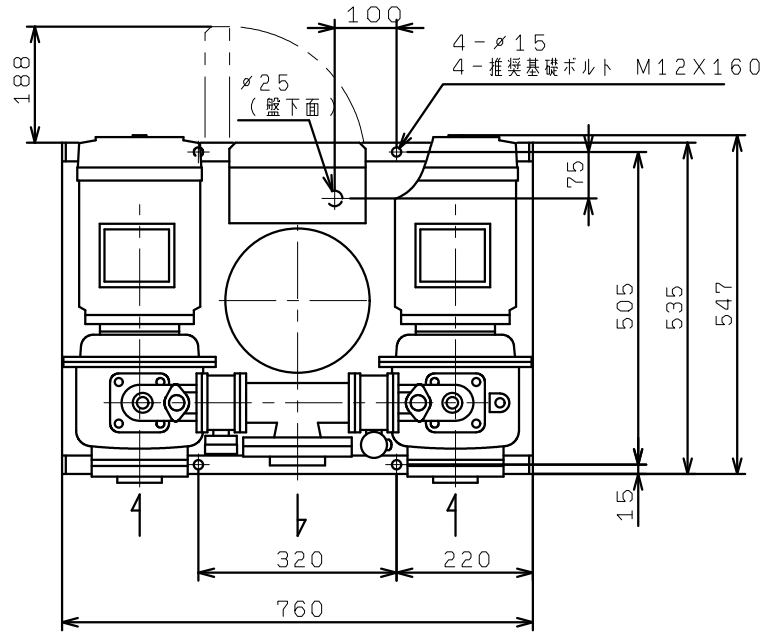