

KB2-505SE3.7
KB2-506SE3.7

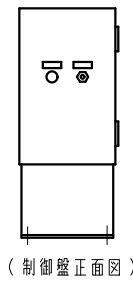
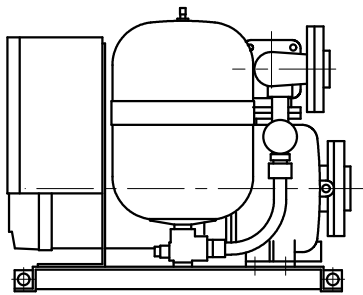
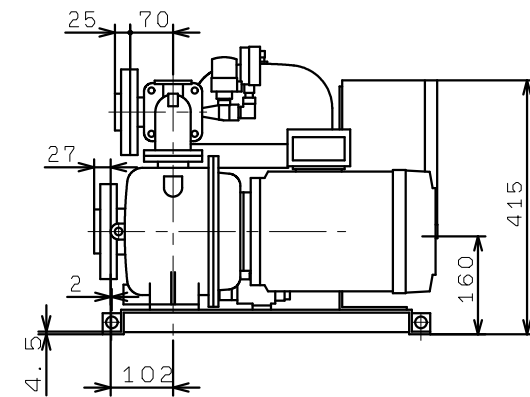
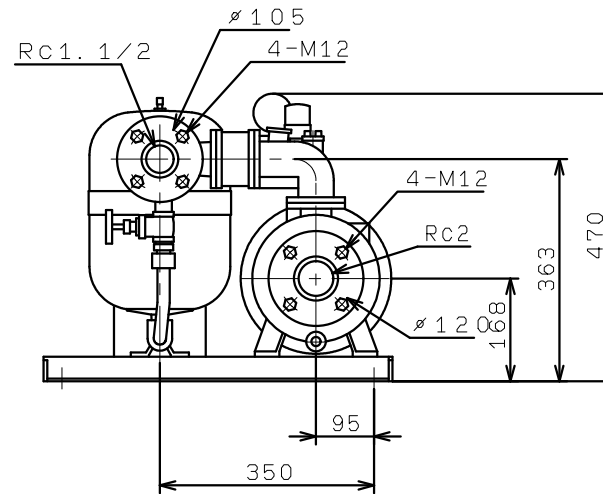
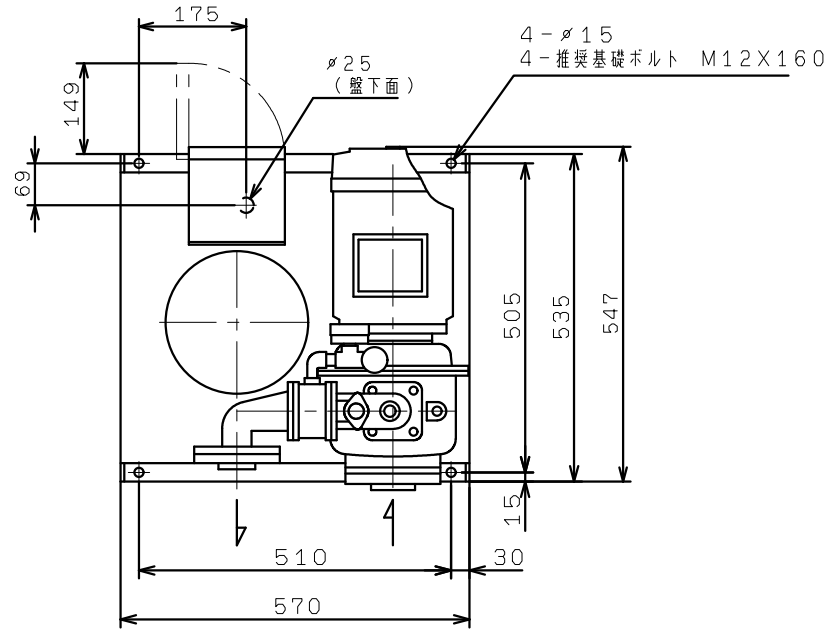

(制御盤正面図)