

KB2-655AE3.7
 KB2-656AE3.7
 (標準, VC40, 94)

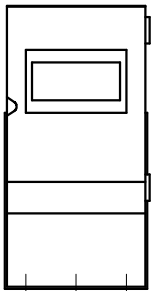

(制御盤正面図)

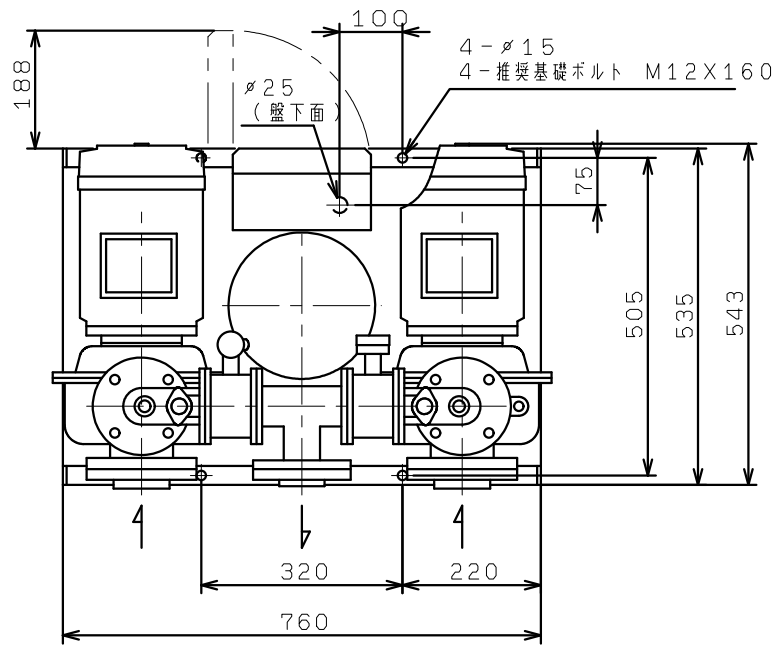