

PJR-100

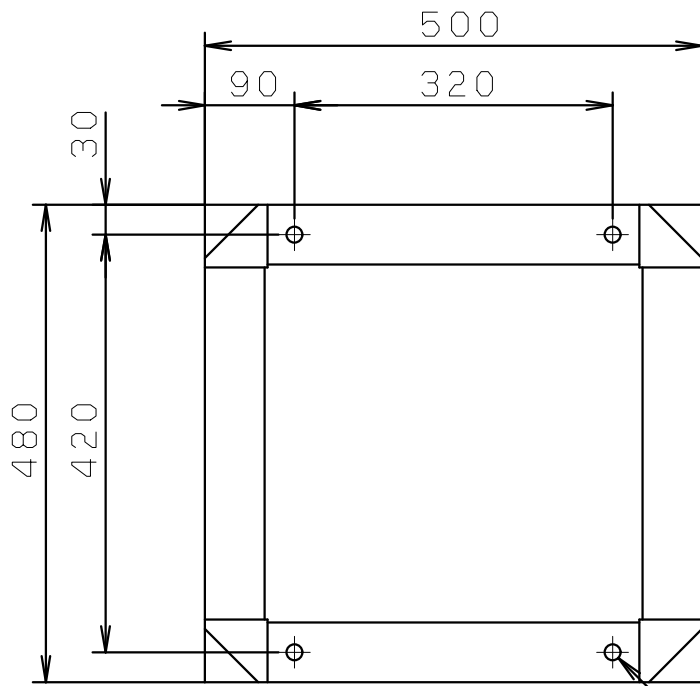

4- ϕ 16 (ポンプ取付穴)

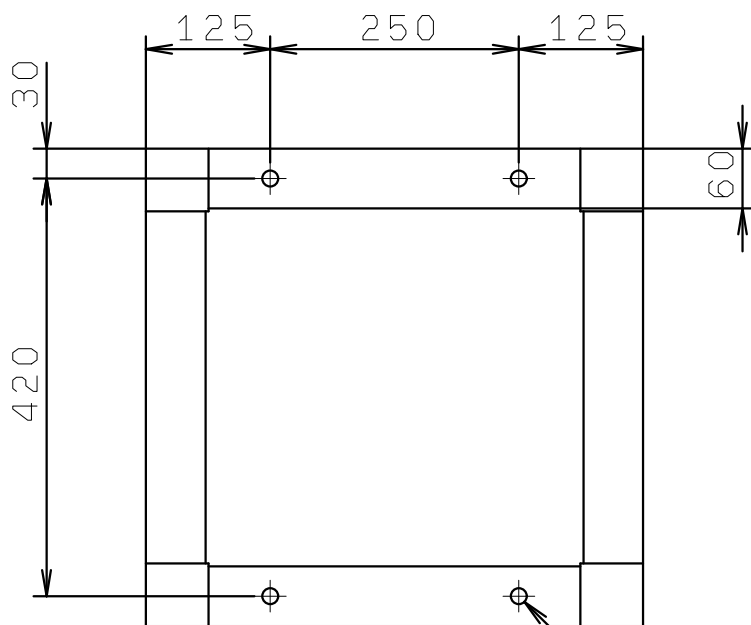
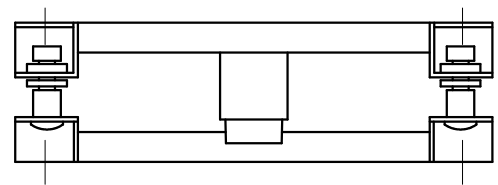
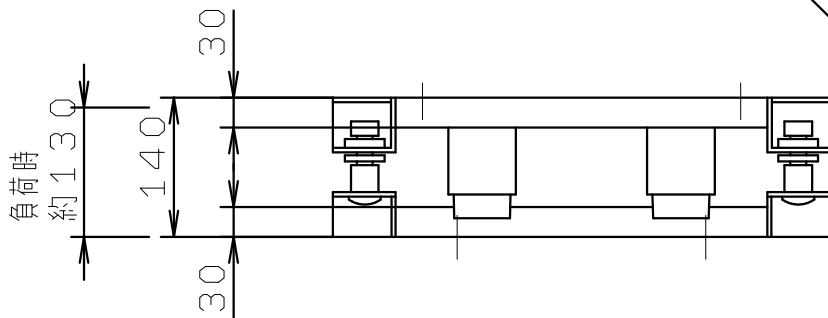

4- ϕ 16 (基礎ボルト取付穴)