

PJR-203

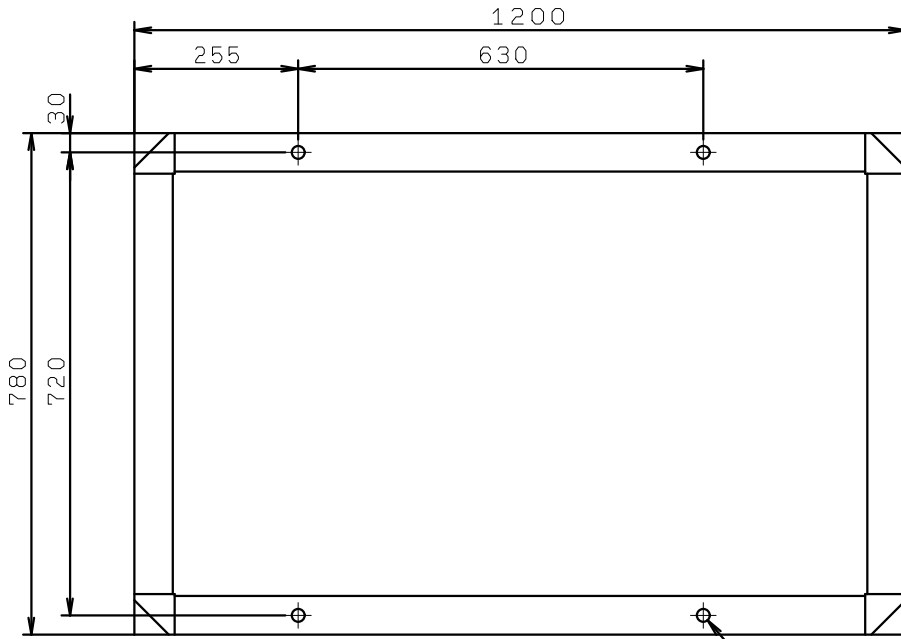

4- ϕ 20 (ポンプ取付穴)

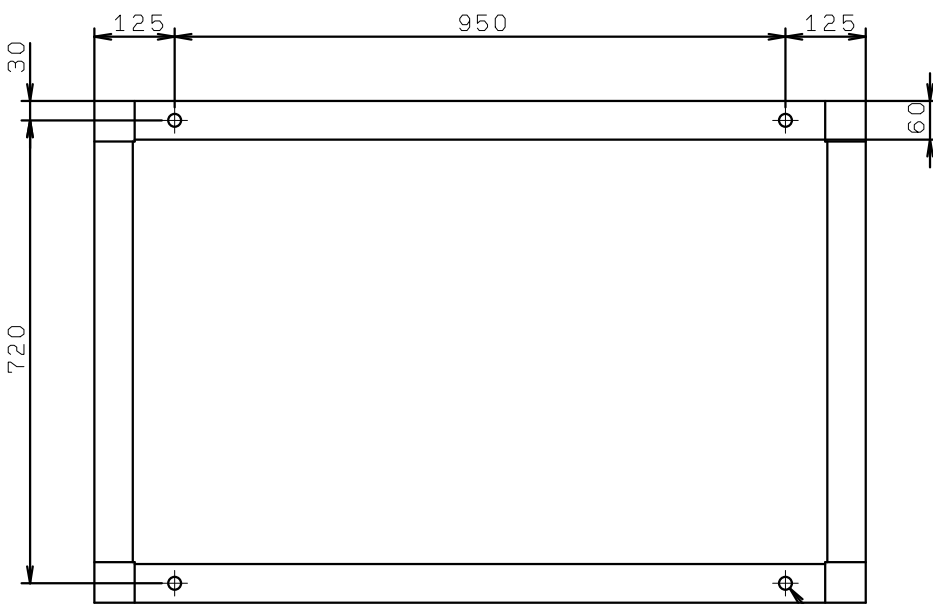
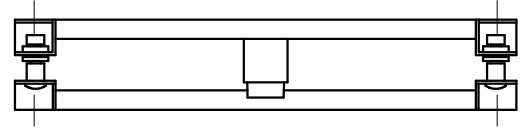
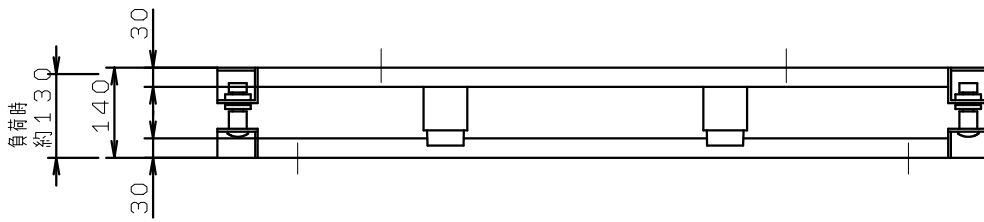

4- ϕ 20 (基礎ボルト取付穴)