

PJR-305

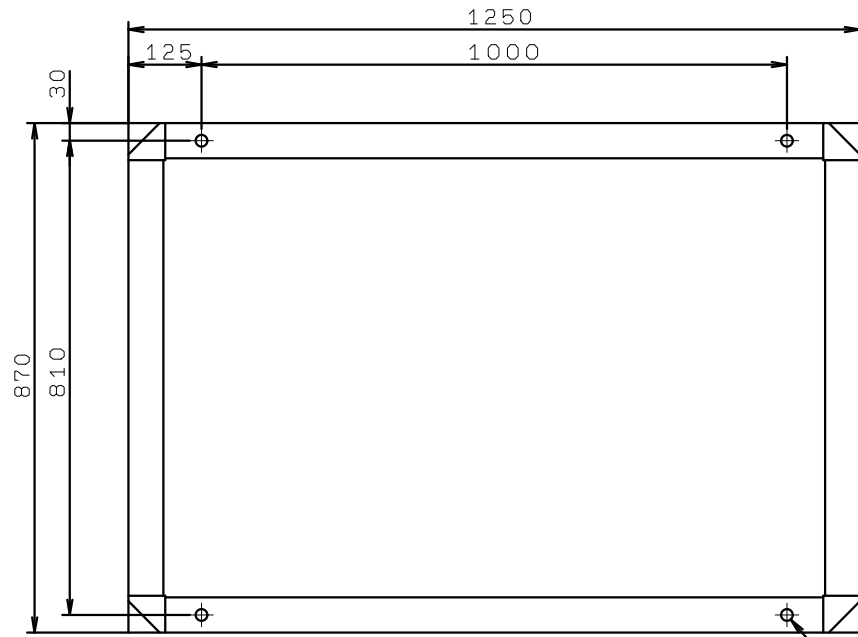

4- $\phi$ 20 (ポンプ取付穴)

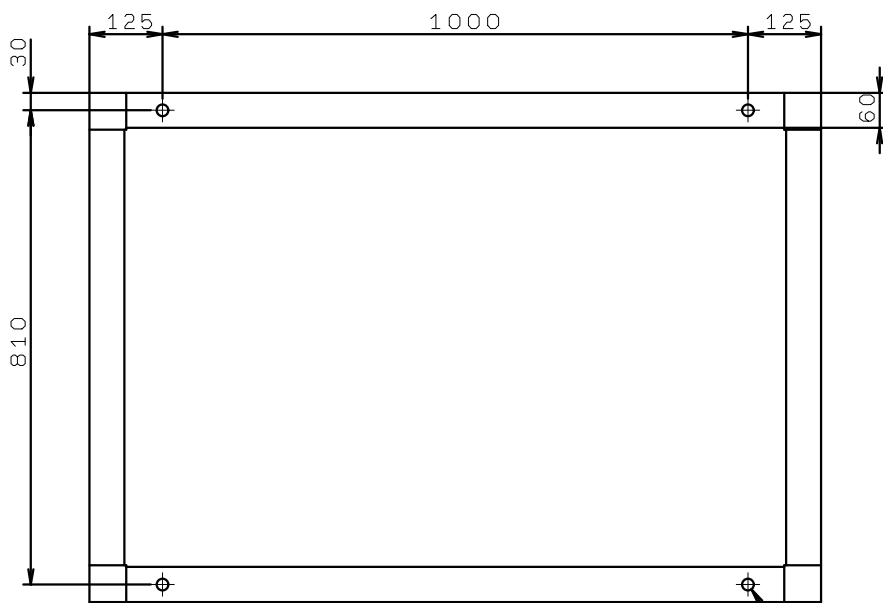
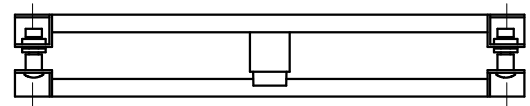
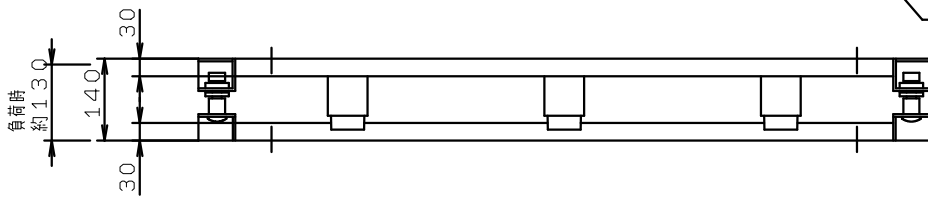

4- $\phi$ 20 (基礎ボルト取付穴)