

SDT-S32
09151210
SCL=1/5

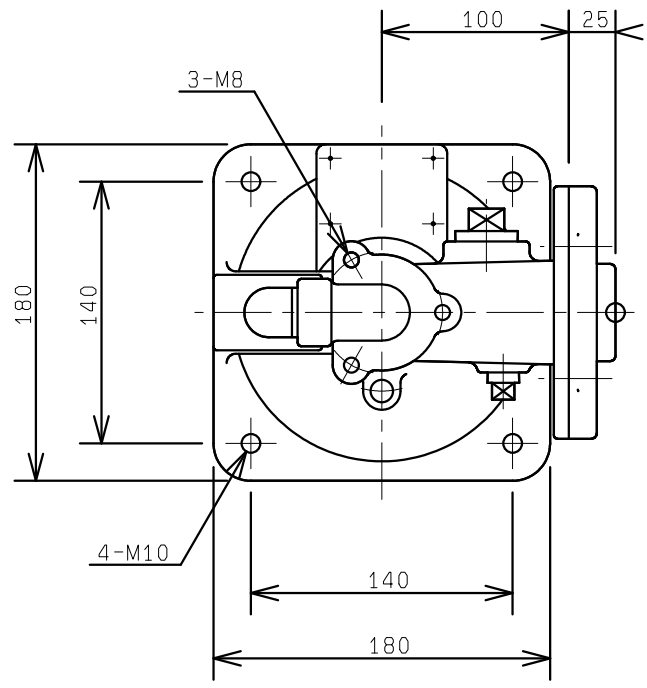

平面図

上面

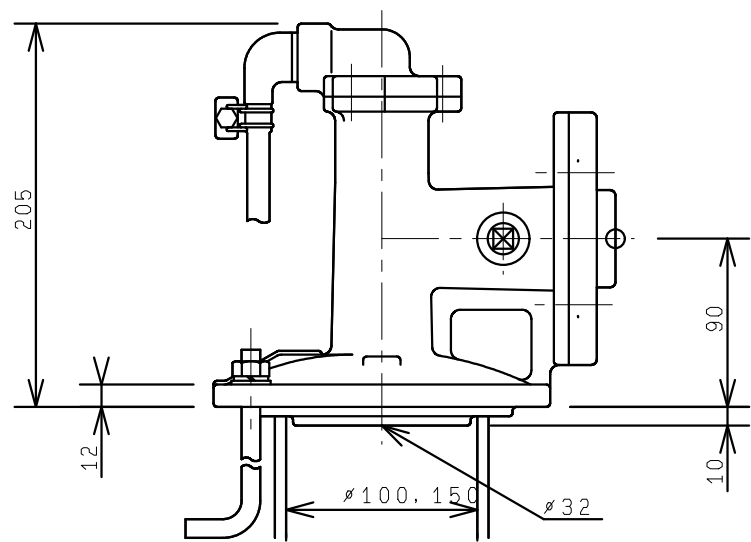

正面図

上面

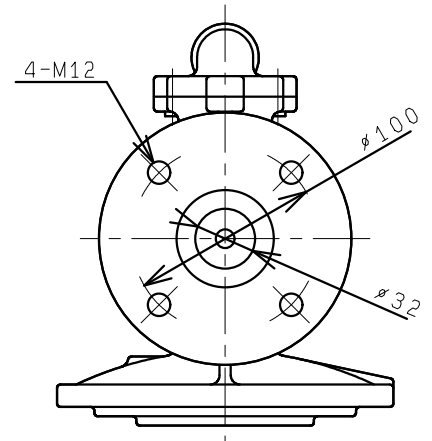
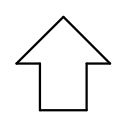

右側面図