

SDT-S40 (バルブ付)
09151310
SCL=1/5

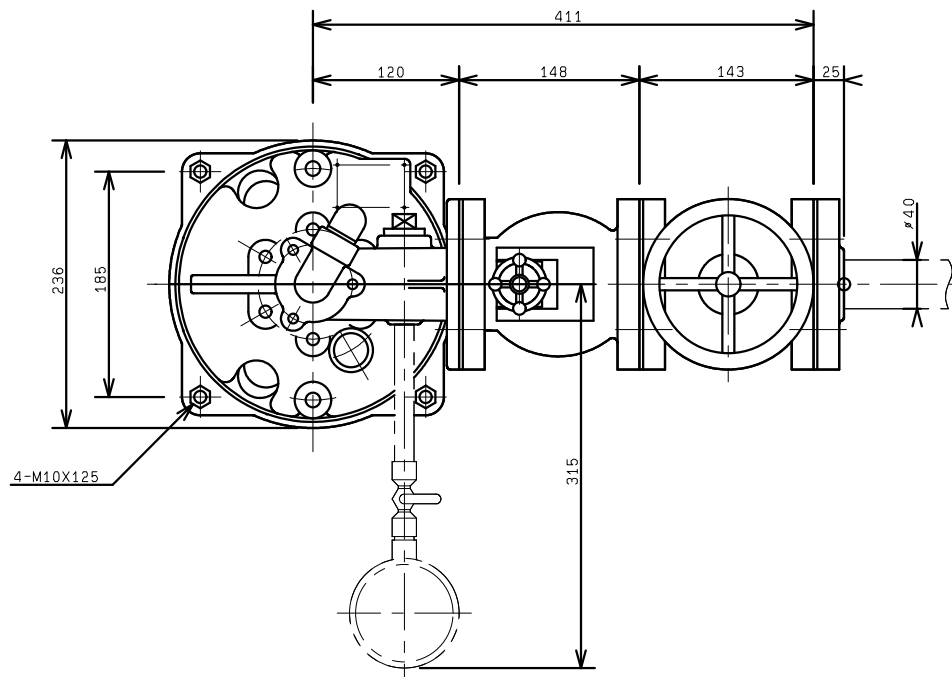

平面図

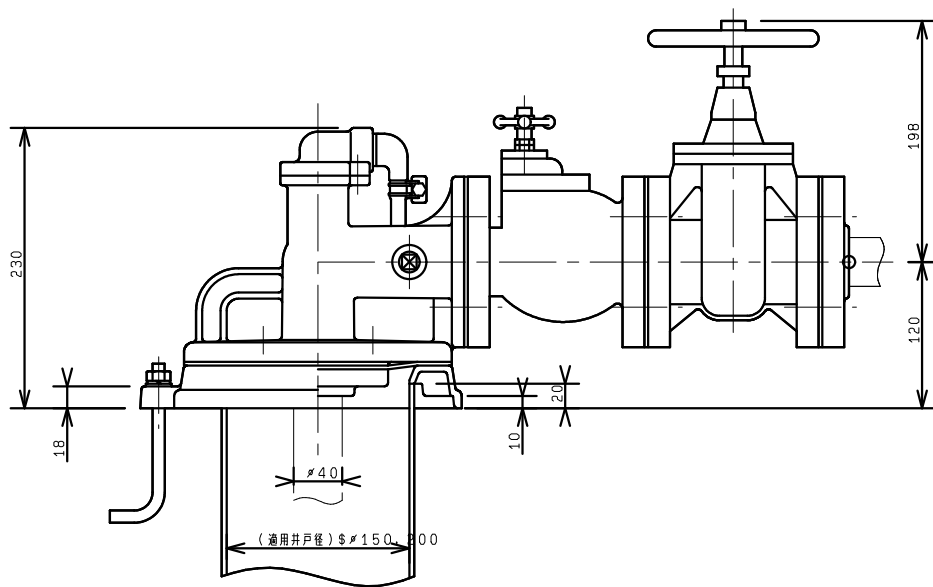

正面図