

SDT2-32 (バルブ付)
09151010
SCL=1/5

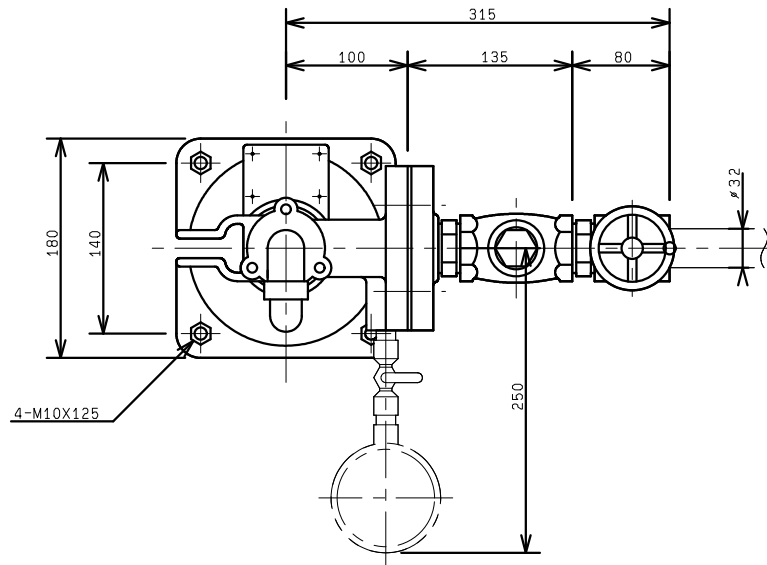

平面図

上面

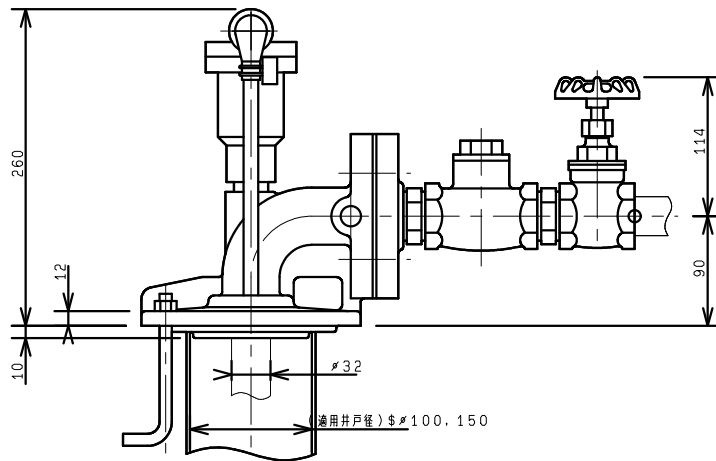

正面図