

VC-65-10KL
03200510

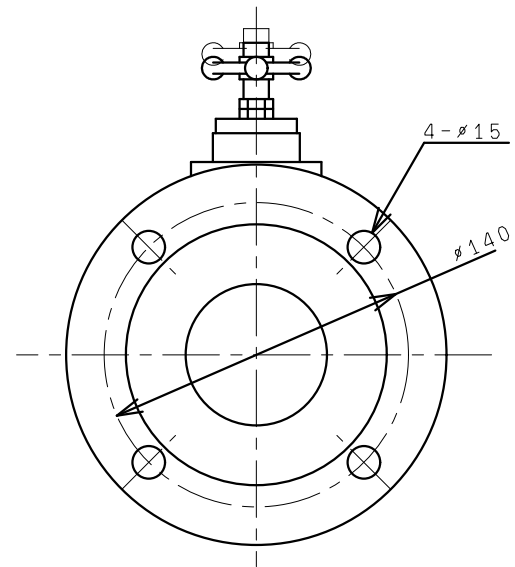

流入口側

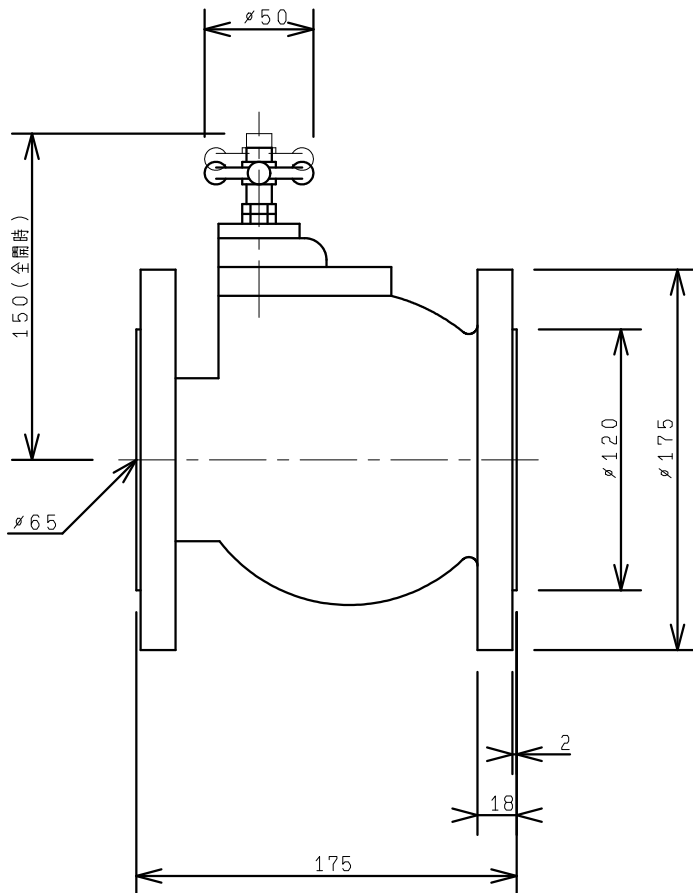
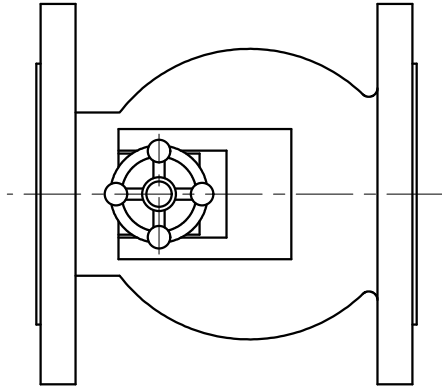